



# SERIE 30I INOX

HIGH RESOLUTION INCREMENTAL SOLID SHAFT ENCODER FOR HEAVY DUTY INDUSTRIAL APPLICATIONS

- Resolution up to 50.000 pulses per turn
- External diameter 90 mm
- Shaft  $\varnothing$  12 mm
- Protection class IP67 according to DIN EN 60529
- Executions mechanical, electronic and special optics forms available on request
- Connection by cable (other cable length available)



Optical Encoder	Incremental Encoder	High shaft load capacity	Vibration and shock resistant	IP67	Temperature range	Express Delivery

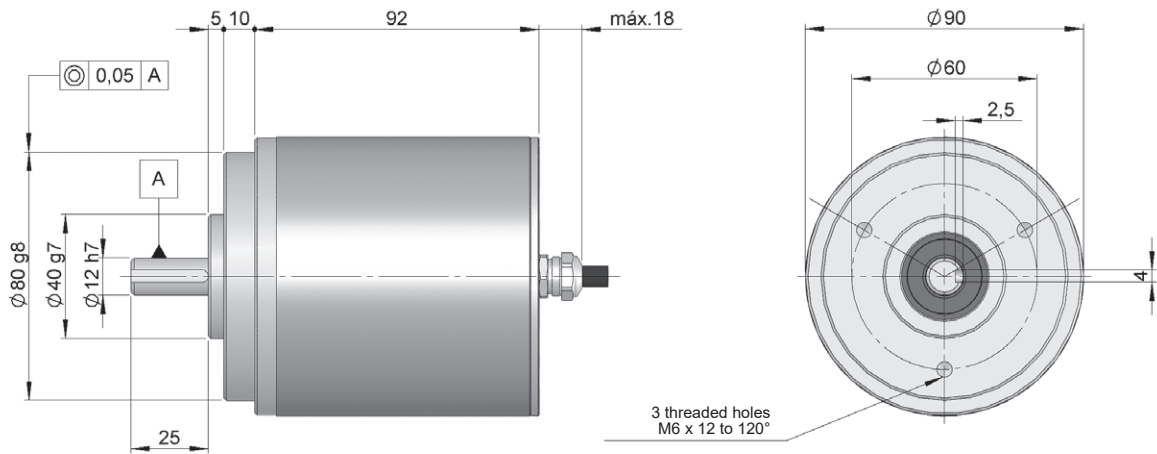

Drawing Encoder S30 IP67, connection type 0

## REFERENCE Reference example : 30I-4200-1024

Serie	Output signals	Connection	Power Supply / Electronic output	Pulses number	Special customer
<b>30I -</b>	<input type="checkbox"/> <input type="checkbox"/>	<input type="checkbox"/>	<input type="checkbox"/> -	<input type="checkbox"/> <input type="checkbox"/> <input type="checkbox"/> <input type="checkbox"/> <input type="checkbox"/> <input type="checkbox"/>	<input type="checkbox"/> <input type="checkbox"/> <input type="checkbox"/> <input type="checkbox"/>
<b>30I.</b> Stainless Steel	<b>30.</b> A <b>40.</b> A+B <b>42.</b> A+B+0 <b>43.</b> A+B+0̃ <b>35.</b> Ã+B̃ <b>36.</b> Ã+B̃+0̃	<b>0.</b> Axial cable	<b>0.</b> 11...30VDC / NPN Open collector 11...30VDC <b>6.</b> 11...30VDC / RS422 5VDC (compatible TTL) <b>7.</b> 5VDC / RS422 5VDC (compatible TTL) <b>9.</b> 11...30VDC / Line driver differential Push-Pull 11...30VDC	(*)	<b>FT00.</b> -40°C

**Order your reference Step file 3D**

[info@encoderhohner.com](mailto:info@encoderhohner.com)  
service available in 24 h

(\*) 10.000 to 50.000 pulses with interpolation. Available 10.000 direct optical pulses without interpolating upon request.



# SERIE 30I INOX

HIGH RESOLUTION INCREMENTAL SOLID SHAFT ENCODER FOR HEAVY DUTY INDUSTRIAL APPLICATIONS

## MECHANICAL SPECIFICATIONS

Materials	Cover: Stainless Steel AISI304 Housing: Stainless Steel AISI304 Shaft: Stainless Steel AISI304
Bearings	Ballraces
Bearings lifetime	1x10 <sup>10</sup> rev.
Maximum number of revolutions permitted mechanically	6000 rpm
Protection against dust and splashes according to DIN EN 60529	IP67
Rotor inertia moment	270 gcm <sup>2</sup>
Starting torque at 20°C (68°F)	≤ 0,05 Nm
Maximum load permitted on axial shaft	80 N
Maximum load permitted on radial shaft	100 N
Weight aprox.	1,2 Kg
Operating temperature range	-20°C to +80°C - Standard -40°C to +80°C - Special Customer FT00
Vibration according to DIN EN 60068-2-6	100 m/s <sup>2</sup> (10Hz...2000Hz)
Shock according to DIN EN 60068-2-27	1000 m/s <sup>2</sup> (6ms)
Maximum pulses per turn	50.000
Axial connection	2 meters cable (other cable lengths available or connector mounted at the end of the cable, upon request)

## OUTPUT SIGNALS

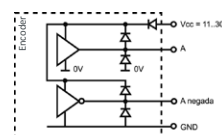
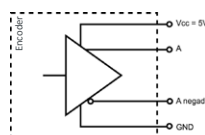
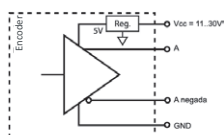
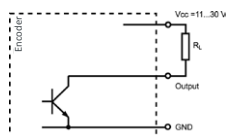



OUTPUT CIRCUIT	NPN Open Collector	RS422 (TTL compatible)	RS422 (TTL compatible)	Push-Pull Differential
Reference code	0	6	7	9
Power supply	11...30 VDC	11...30 VDC	5 VDC ±5%	11...30 VDC
Output voltage	11...30 VDC	5 VDC	5 VDC	11...30 VDC
Consumption	40 mA	Typical: 80 mA Max: 160 mA	Typical: 70 mA Max: 150 mA	Typical: 45 mA Max: 150 mA
Max. load capability / channel	40 mA	±20 mA	±20 mA	±30 mA
Length of cable allowed	50 m (24 VDC)	1200 m	1200 m	100 m
"Low" signal level	VOL < 0.4 VDC (24 VDC)	VOL < 0.5 VDC	VOL < 0.5 VDC	VOL < 2.5 VDC
"High" signal level	VOH > 22 VDC (24 VDC)	VOH > 2.5 VDC	VOH > 2.5 VDC	VOH > VCC - 3 VDC
Frequency	100 kHz	300 kHz	300 kHz	200 kHz
Short circuit protection	Not permanent	Yes	Yes	Yes
Protection polarity inversion	Yes	Yes	No	Yes

Channel B leads (90° electric) channel A, view from the shaft, shaft rotating clockwise

# SERIE 30I INOX

HIGH RESOLUTION INCREMENTAL SOLID SHAFT ENCODER FOR HEAVY DUTY INDUSTRIAL APPLICATIONS

## CONNECTION

	 <b>95.0008002</b> Cable 2x2x0,14+1x0,14	 <b>95.0008003</b> (* Cable 3x2x0,14+2x0,34
GND	Yellow	Black
VCC	White	Red
A	Brown	Yellow
B	Green	Green
$\tilde{A}$		Brown
$\tilde{B}$		Blue
0 (reference)	Grey	Grey
$\tilde{0}$	Grey	Orange

(\* Cable 3x2x0,14+2x0,34 only for encoders with inverted signals.

## ACCESSORIES EXAMPLES

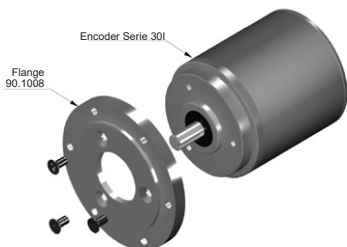

All the accessories available in the section "MOUNTING ACCESSORIES".

